

Control /Operation Voltage	:24VDC \pm %20
Power Consumption	:30W
Passing Block	:With controlled turning tripod arms positioned with 120 degrees
Tripod Locking	:With 24 V DC selenoids; locks when the selenoids are pulled. (In Emergency, system is shut down and turnstiles provide free passing in both directions.)
Passing Direction Control	:Free bi-directional entry-exit control
Tripod Position Dedection	:Direction of the tripod position with two microswitches.
Motion Control	:When the cycle starts to one direction, the reverse is blocked and after a half turn the rest of the cycle is completed, automatically and smoothly by a hydraulic shock absorber.
Installation	:Simple & easy installation with a special pedestal.
Operation Temperature	: - 20° C - + 70° C
Indicators	:One light indicator on both directions
Dimensions	:250x963x970 mm
Weight	:42 kg
Optional Accesories	:Drop-arm, remote control, button unit.

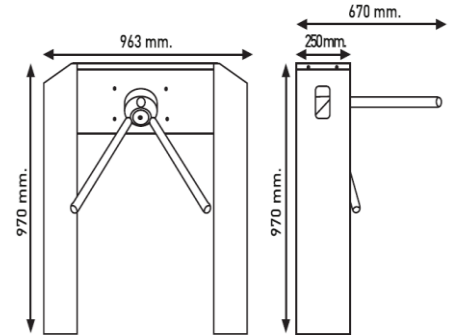

- **304 Stainless Steel Body**
- **Easy to Use, Bi-directional Control**
- **Strong Ergonomic Design**
- **% 100 Turkish, Production Continuity**
- **Certified Quality**
- **Continuous Service and Spare Parts Support**